

# Aluminum Battery Enclosure Design

Andreas Afseth

Technical Director, Automotive Body Sheet, North America  
CONSTELLIUM





# Agenda

- ▲ 1. Constellium
- ▲ 2. Aluminum usage in Battery Electric Vehicles and Battery Enclosures
- ▲ 3. Drivers for material choice in Battery Electric Vehicles
- ▲ 4. Specific requirements for Battery Enclosures
- ▲ 5. Summary and conclusions

# Constellium At A Glance

## Key Figures

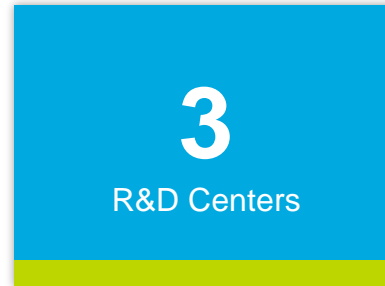

## Products And Solutions

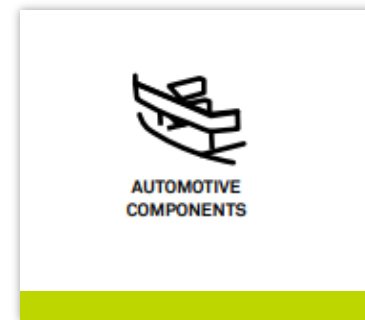
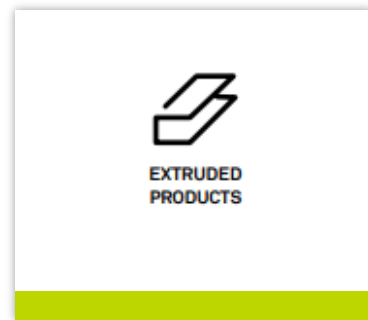
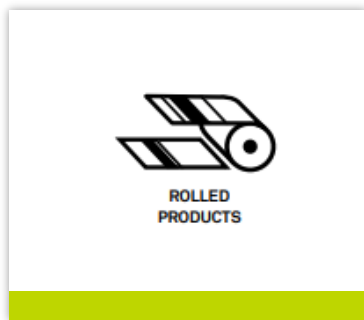

# Where We Operate



> An extensive footprint for design, development and production in Europe, North America and China

# Constellium activity in global Automotive

Car Body Closures



Decorative Parts

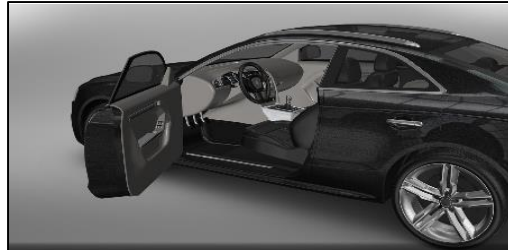

Heat Exchangers



Body Structures

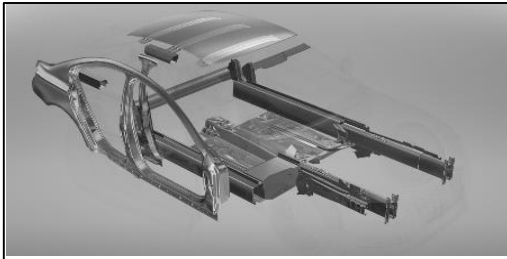

Crash Management Systems



Battery Enclosures & Cooling Plates

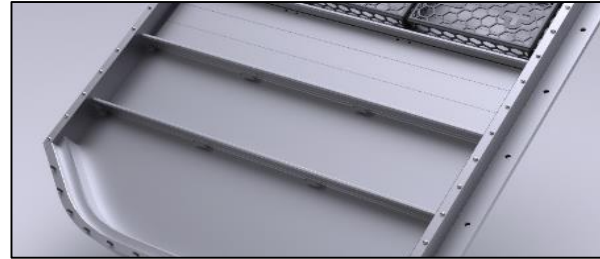



# Agenda

- ▲ 1. Constellium
- ▲ **2. Aluminum usage in Battery Electric Vehicles and Battery Enclosures**
- ▲ 3. Drivers for material choice in Battery Electric Vehicles
- ▲ 4. Specific requirements for Battery Enclosures
- ▲ 5. Summary and conclusions

# Aluminum content in North American Light Vehicles

Aluminum continues to be the fastest growing material in automotive applications. Growth from 2020 onwards is driven by substitution of steel in platform parts as well as through significantly higher aluminum content of battery electric vehicles,

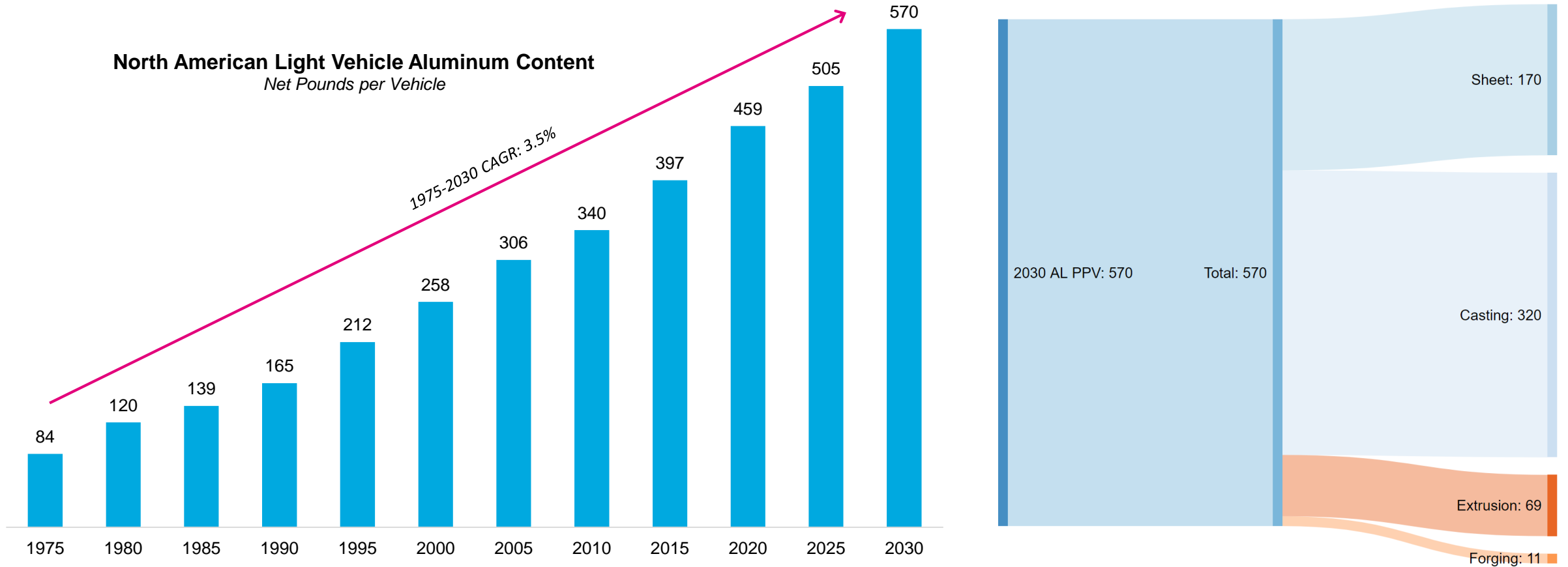

# Automotive Aluminum Applications by Parts

## Platform parts (structural)

- Body-in-white
- Body closures
- Chassis
- Suspension and frame parts
- BEV: Battery Enclosure

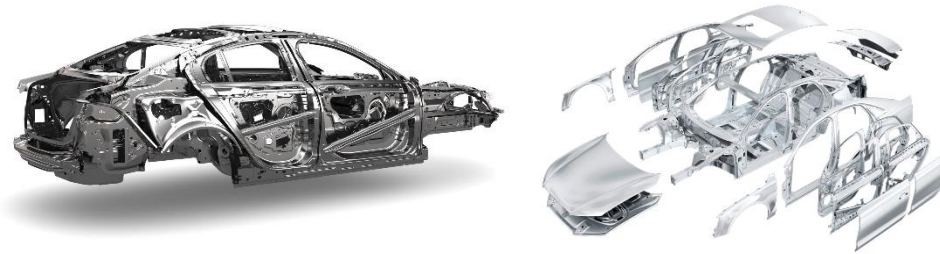

Only in Electric vehicles

## Component parts (non-structural)

- Powertrain
- Driveline
- Transmission,
- Trim
- Brake
- Steering
- Wheels
- Heat exchangers
- BEV: Electric Motor housing
- BEV: Converter housing
- BEV: Gearbox housing
- BEV: Battery Cables

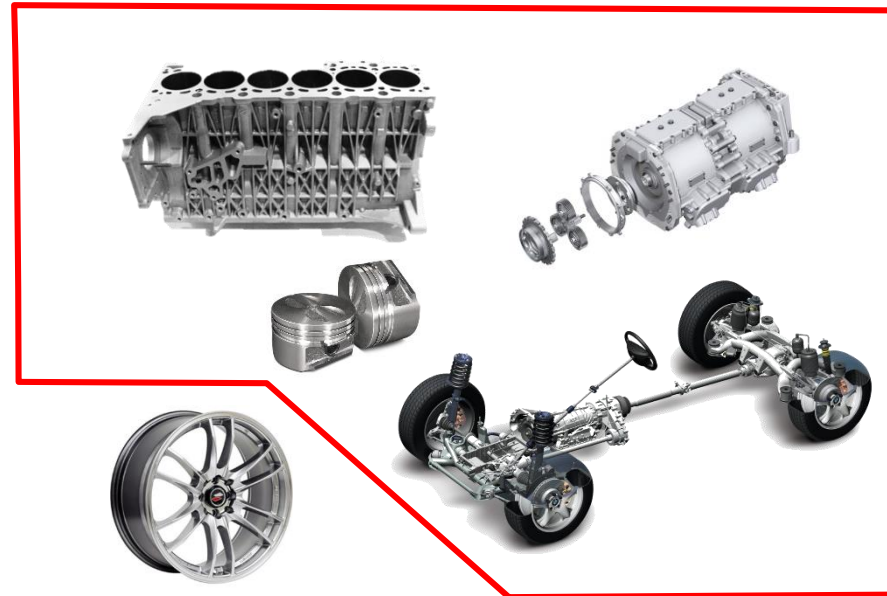

Only in non-BEV vehicles

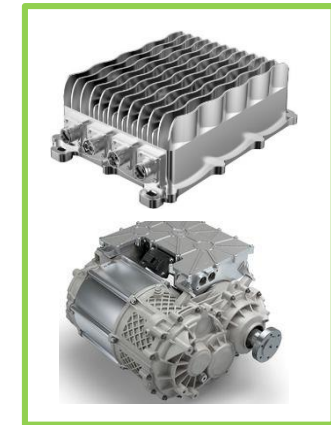



# Aluminum Content BEV vs non-BEV

BEVs use more than three times as much aluminum than non-BEVs in platform parts today. This difference will be reduced to a factor of ~2 by 2026 as aluminum platform use is increased in non-BEVs and several smaller BEV models are launched.

PPV – BEV vs. ICE

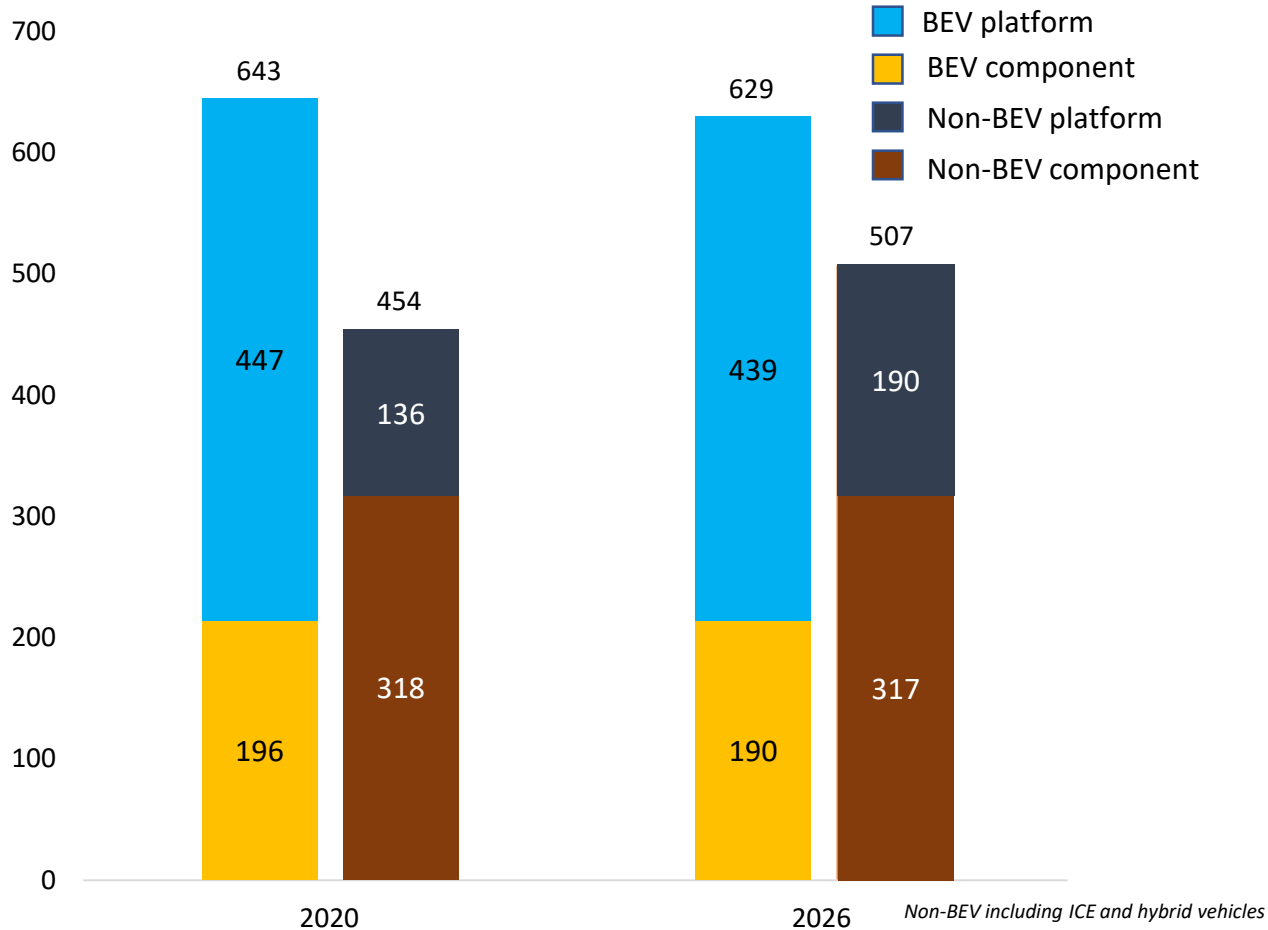

BEV PPV Share by Part Family

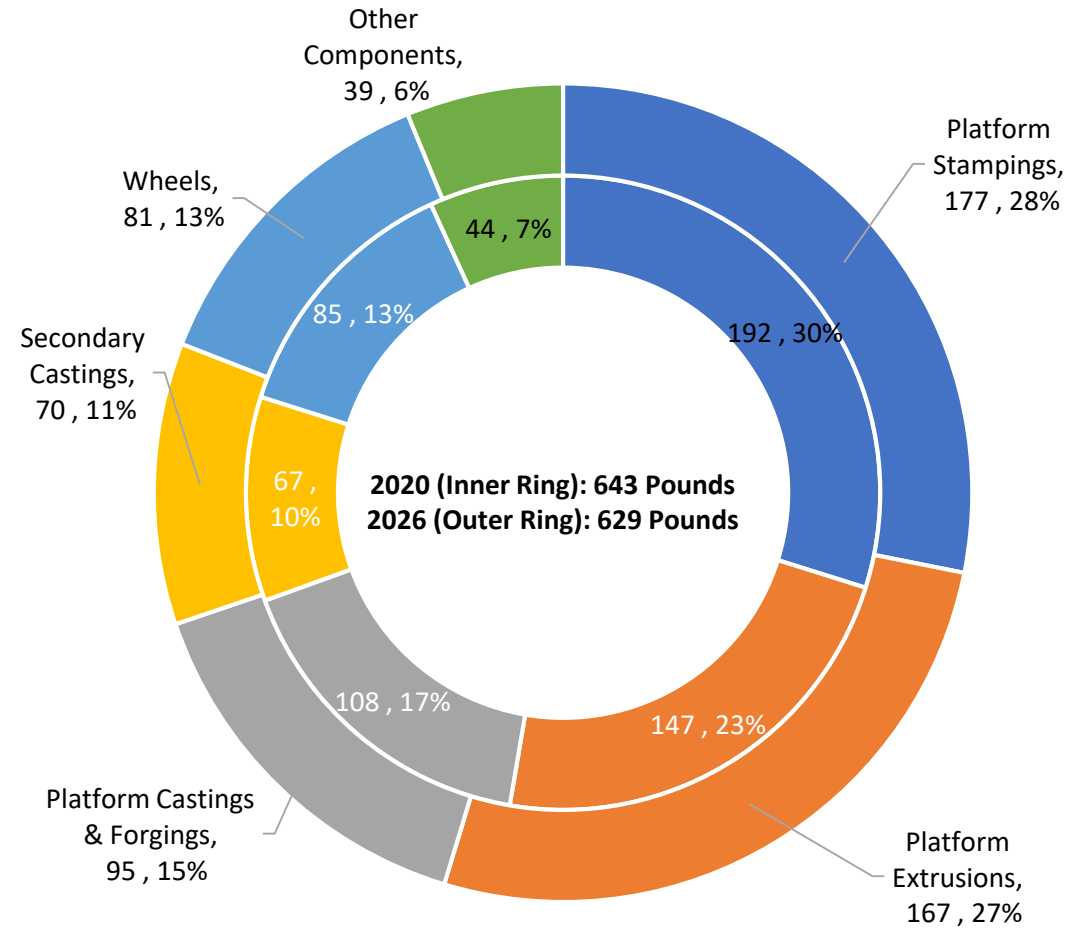

# Aluminum Content tradeoff

## Eliminated ICE Parts

- Powertrain**
  - Internal combustion engine related components, such as block, cylinder head, cam cover, oil pan, piston, etc., are eliminated on BEVs
- Transmission and Driveline**
  - Transmission case, valve body, clutch housing, etc. are the major aluminum components removed from ICE models
  - For AWD and RWD models, components such as transfer case, drive shaft, differential carriers are also not necessary on BEVs

## Added BEV Parts

- BEV Powertrain**
  - Aluminum casting or extruded traction motor housing will compensate the loss from engine parts; dual motor models will need two housings
  - Some BEV powertrain may need reduction gearbox, of which case is normally aluminum casting
  - Electrical units such as inverter/converter/BMS are also packed in aluminum casting housings
- BEV Platform**
  - BEVs have stronger needs for lightweighting than ICE models to improve range.
  - Aluminum penetration of platform parts, including closure and body platform components, is higher on BEVs
  - With more lower-segment BEVs entering the market, the average content of aluminum platform parts is likely to decrease after 2022

## Aluminum Content Change – BEV to ICE

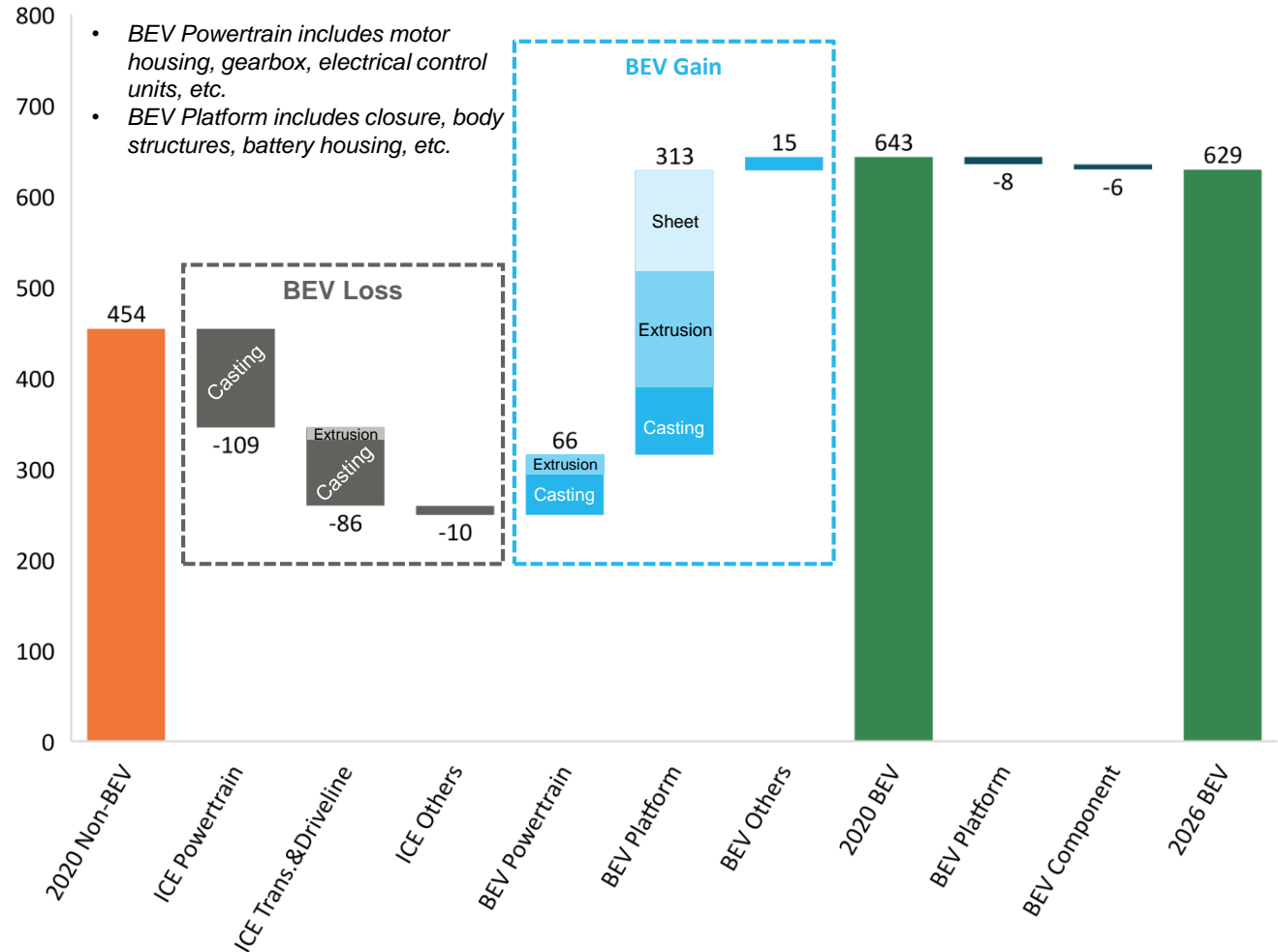

# Major Aluminum Parts in BEV

## Battery Pack Structure

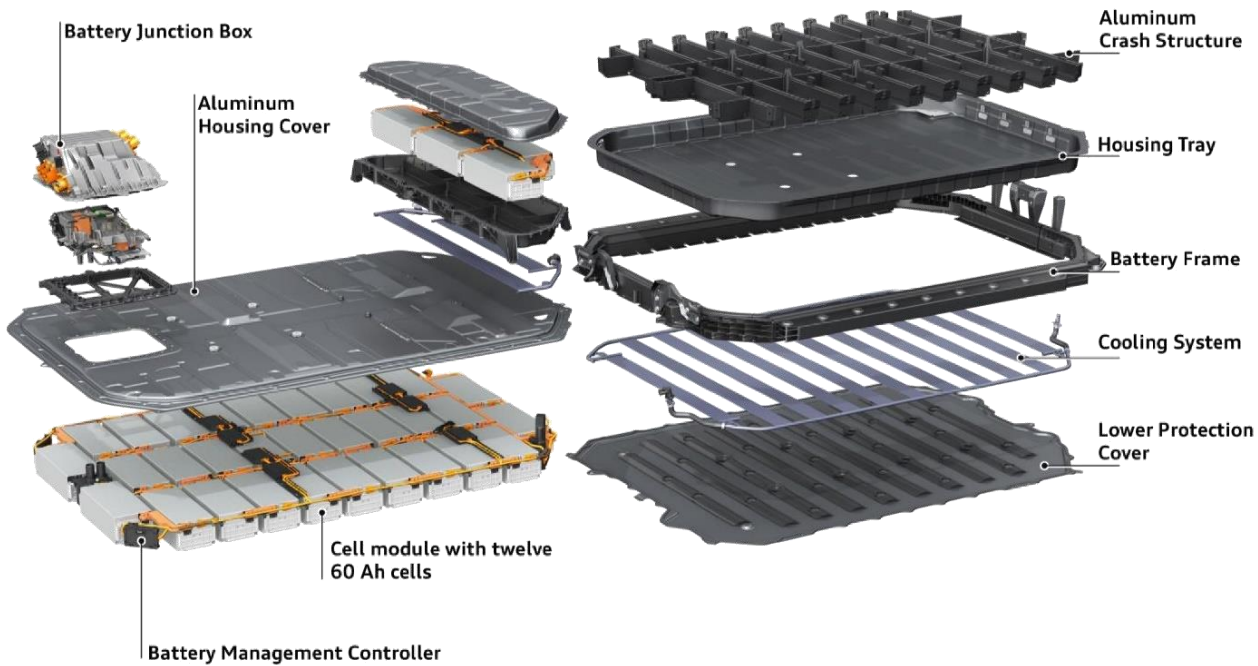

Component	Typical Product Type	Typical Weight
Frame & structure	Extrusion	75 Lbs.
Cooling System	Extrusion/Sheet	10 Lbs.
Top Cover	Sheet	15 Lbs.
Tray / Lower cover	Sheet / Extrusion / Casting	45 Lbs.

## Traction & Electrical System

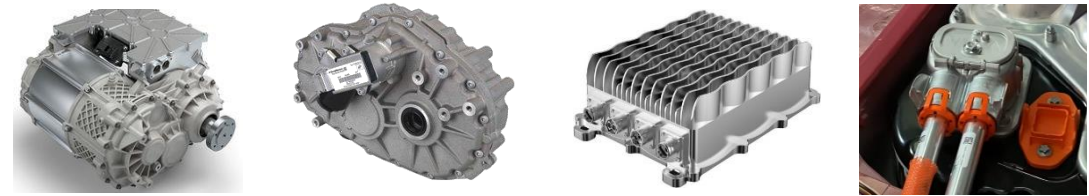

Component	Typical Product Type	Typical Weight
Traction Motor Housing	Casting, Extrusion	30 lbs.
Reduction Gearbox	Casting	25 Lbs.
Inverter/Converter Housing	Casting	6 Lbs.
BMS Housing	Casting	5 Lbs.
Wiring Tube/Connector	Extrusion, Casting	4 Lbs.

## Body and Closure



Component	Typical Product Type	Typical Weight
Body Structure	Casting, Extrusion, Sheet	200 Lbs.
Closures	Sheet	100 Lbs.

# Battery Enclosure – Material choice current vehicles

The majority of long range BEVs in current production worldwide use aluminum as the main material for the battery enclosure.

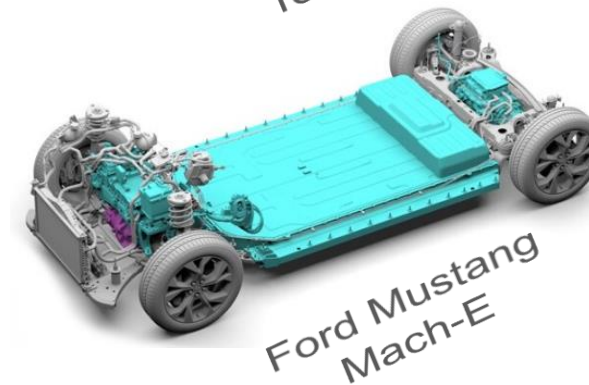
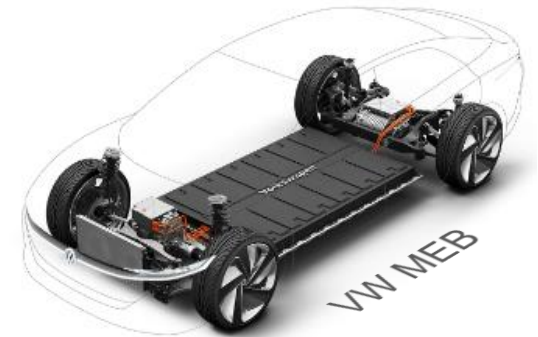
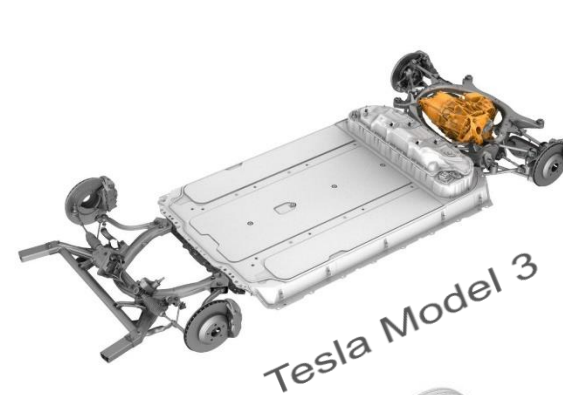
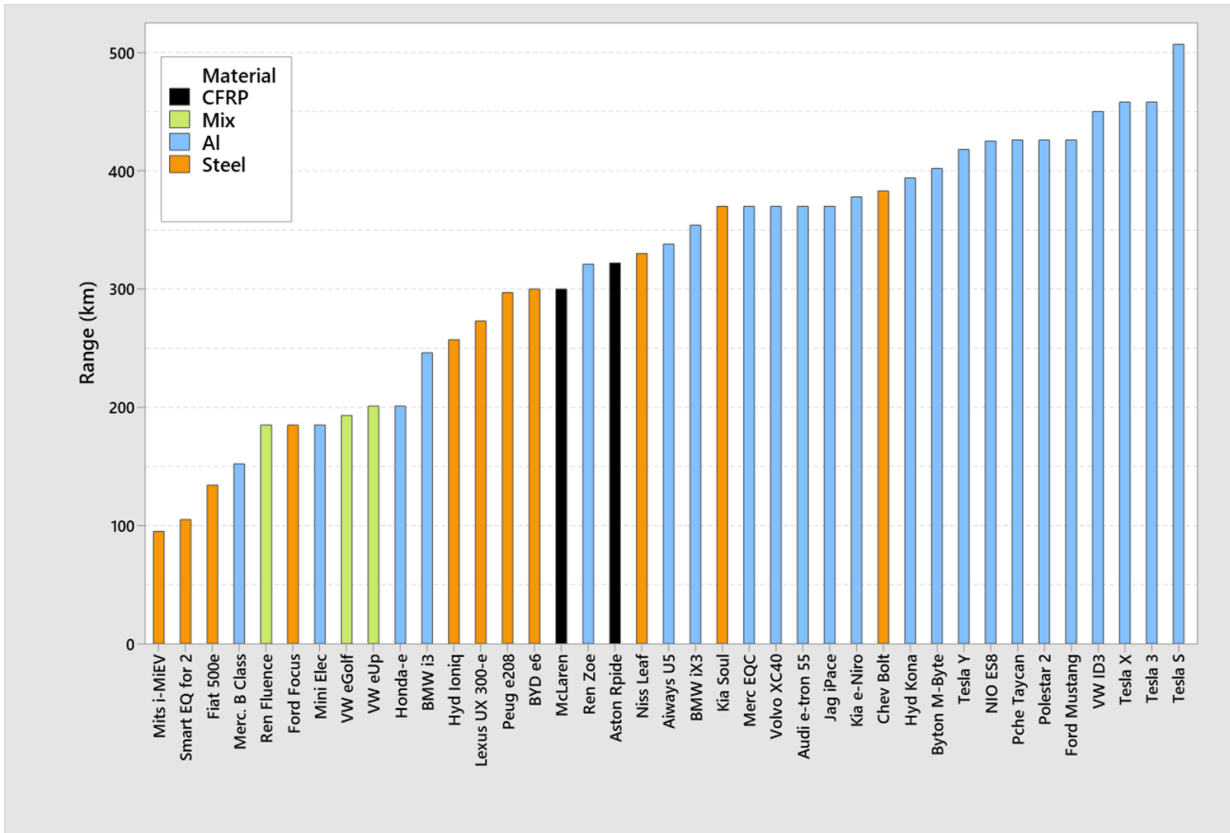



# Agenda

- ▲ 1. Constellium
- ▲ 2. Aluminum usage in Battery Electric Vehicles and Battery Enclosures
- ▲ **3. Drivers for material choice in Battery Electric Vehicles**
- ▲ 4. Specific requirements for Battery Enclosures
- ▲ 5. Constellium development and prototyping capabilities

# Drivers for Material Choice and Lightweight design

## Performance

Range  
Acceleration / driving dynamics  
Towing capability / payload  
Energy consumption  
Charging time  
Safety / crash / fire resistance  
Durability for lifetime of vehicle

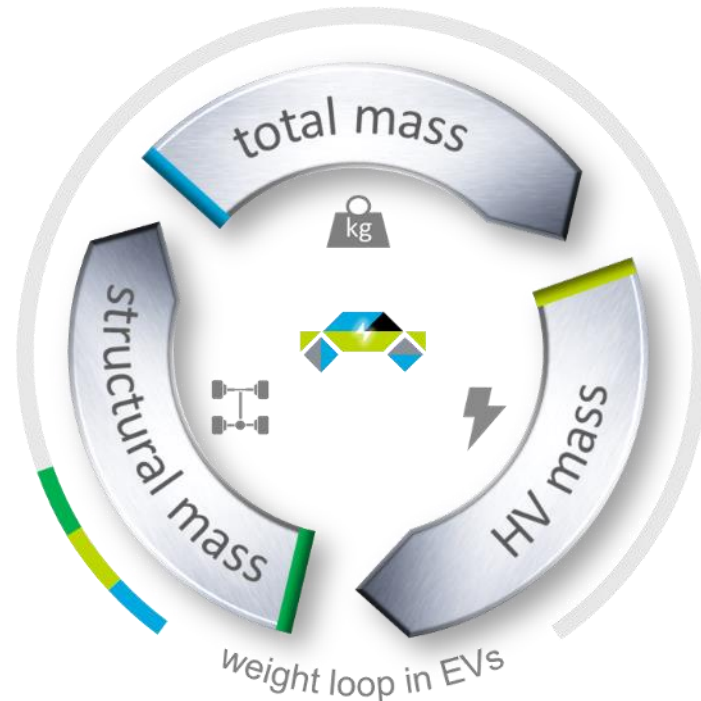

## Cost

- Component material cost
- Component manufacturing cost
- Cost impact of re-sized structure/powertrain
- Total solution cost

## Sustainability

Life Cycle Analysis  
CO<sub>2</sub> impact of manufacturing phase  
CO<sub>2</sub> impact of use-phase  
End-of-life recycling / re-use

# Drivers for material choice: Performance

Range ◀▶ Driving dynamics ◀▶ Energy consumption ◀▶ Towing capacity / payload

- A lighter vehicle body will always have a better overall balance of key BEV performance criteria.
- An optimized aluminum design for individual components or complete vehicle body structure is ~ 40 % lighter than an equally optimized steel design.
- A cheaper but heavier steel body can achieve the same range and even acceleration as a light aluminum body by adding more batteries and using more powerful electric motors → secondary weight gain
- 100 kg primary increase in body structure weight of a long-range electric SUV require around 3.5% larger battery and 6% more powerful motor to achieve same range and acceleration. (\*)

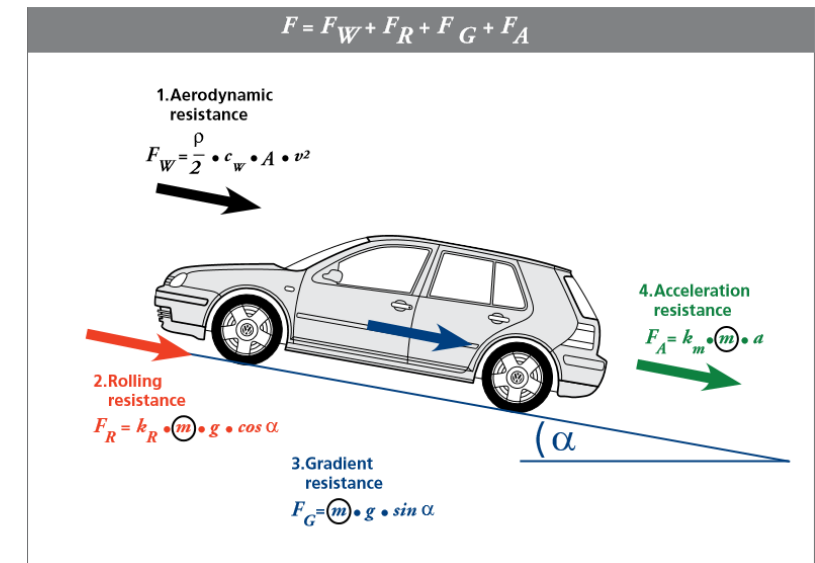

\* <https://ee.hydro.com/automotivewebinar>

# Drivers for material choice : Cost

- Raw material cost comparison  $\neq$  value of light-weight design.
- Cost of weight saving by design or material substitution must be considered in relation to the secondary weight and cost saving of body structure, battery and component re-sizing.
- Historically high battery cost (\$/kWh) and low storage density (Wh/kg) made value of light weight construction obvious = savings just from downsized battery packs easily paid for increased material cost when choosing aluminum over steel.
- As battery costs and energy density continue to improve, the \$-value of light-weighting will be reduced, and we expect to see increased material competition.
- The value proposition of light-weight aluminum design is more compelling for large and/or performance-oriented vehicles and we expect to see aluminum remain dominant in these segments.

## Cheaper Batteries

The cost of storing a kilowatt-hour of electricity has plunged and is expected to drop further

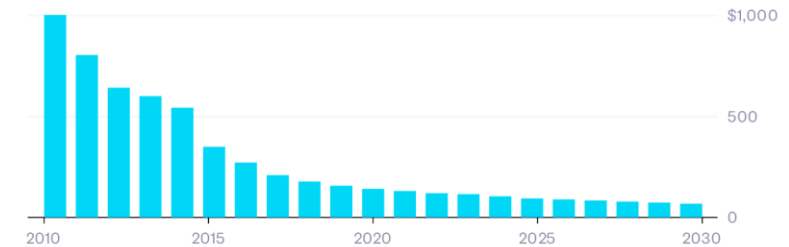

Note: Figures for 2018 and beyond are projections  
Source: BNEF

BloombergQuickTake

## Battery-cell energy densities have almost tripled since 2010

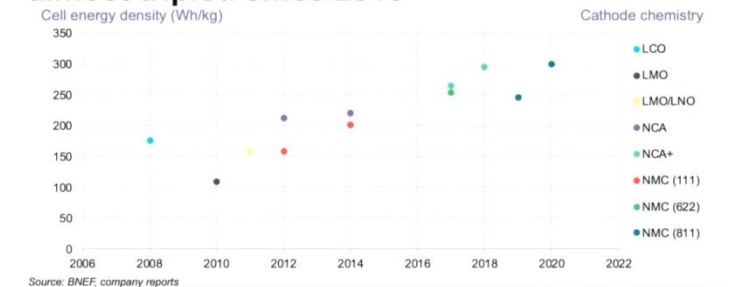

Source: BNEF; company reports

BloombergNEF



# Drivers for material choice: Sustainability

- Green House Gas (GHG) impact of design and material choice is best assessed on specific cases by Life Cycle Analysis respecting ISO 14040/44 guidelines.
- There are limited unbiased studies on the GHG impact of light-weight design with aluminum compared to other materials specific for all-electric vehicles.
- Results can be very misleading if using assumptions that do not reflect reality for CO<sub>2</sub> emissions during primary manufacturing of aluminum or how much aluminum is recycled.
- Key facts to explain the potential net positive carbon footprint of light-weighting BEVs with aluminum are:

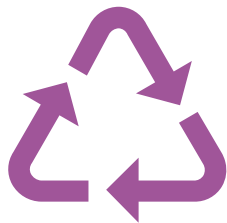

**At the end of a vehicle's life, automotive aluminum is 96% recycled and reused for automotive parts.**

(Source: WPI 2016, 2018)

## CO<sub>2</sub> content per kg

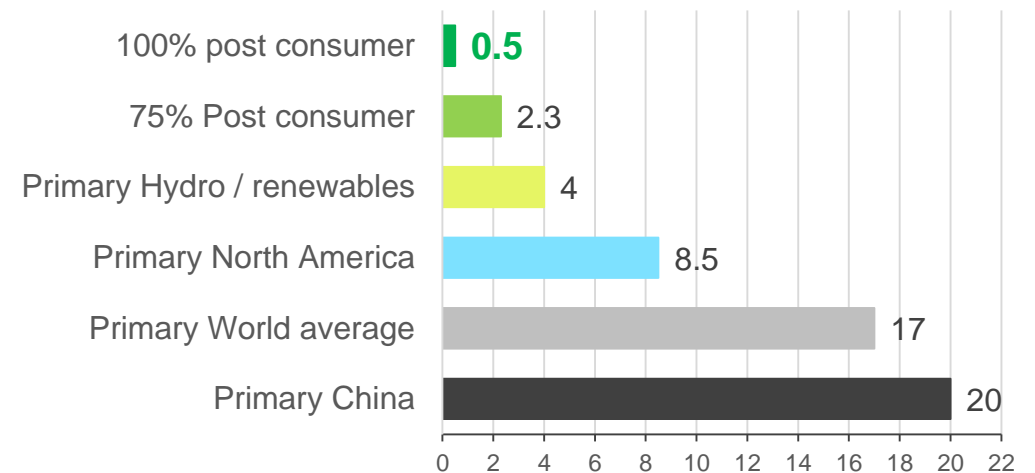



## Poll #1

Which criteria is most important for you personally to choose a battery electric vehicle over an ICE or hybrid car ?

A = Longer range

B = Reduced charging time

C = Minimal lifecycle CO<sub>2</sub> footprint

D = Cost, will only buy a BEV if it is cheaper than the alternatives



# Agenda

- ▲ 1. Constellium
- ▲ 2. Aluminum usage in Battery Electric Vehicles and Battery Enclosures
- ▲ 3. Drivers for material choice in Battery Electric Vehicles
- ▲ **4. Specific requirements for Battery Enclosures**
- ▲ 5. Summary and conclusions

# Battery Enclosures Design Criteria

## Safety: Crash, impact and fire resistance:

- Vehicle crash / side impact resistance
- Bottom impact resistance
- Firewall protection of passenger compartment

## Sealing, shielding and durability

- Waterproof seal of battery modules
- Electromagnetic shielding
- Corrosion resistance and bond durability for life-time of vehicle.



## Thermal management:

- Integrated heating and cooling
- Guarantee no thermal runaway
- Optimize battery capacity and lifetime

## Vehicle integration, space and weight optimization:

- Torsional stiffness
- Modularity to accommodate different battery sizes
- Respect volume & allowable dimensions
- Minimize weight at cost target

# Battery Enclosures Main Aluminum Parts

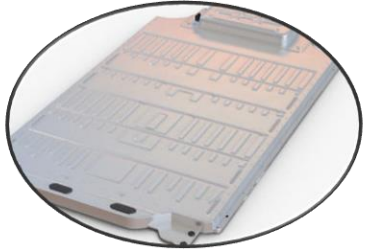

## Top protection cover

- Seals the enclosure and protects passenger compartment from heat / fire
- Stamped aluminum sheet with high formability

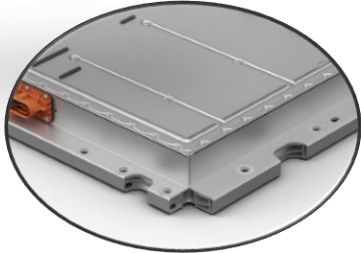

## Structural frame and cross members

- Protects the cells from intrusion in crash
- Most commonly in extruded profiles
- Requires very high strength alloys combined with high ductility

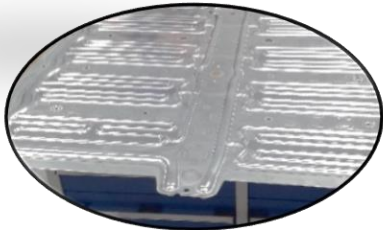

## Cooling plate / thermal management system

- Ensures stable operating temperature for the cells
- Can be either brazed sheet or extruded profiles. May also be integrated in bottom cover



## Bottom plate / lower protection cover

- Protects the cells from undercarriage impact, road debris etc.
- Welded extrusion and sheet solutions are both used
- Sheet can be flat or stamped to also act as tray
- Requires high strength / high ductility alloys

# Constellium Automotive Body Sheet Alloys

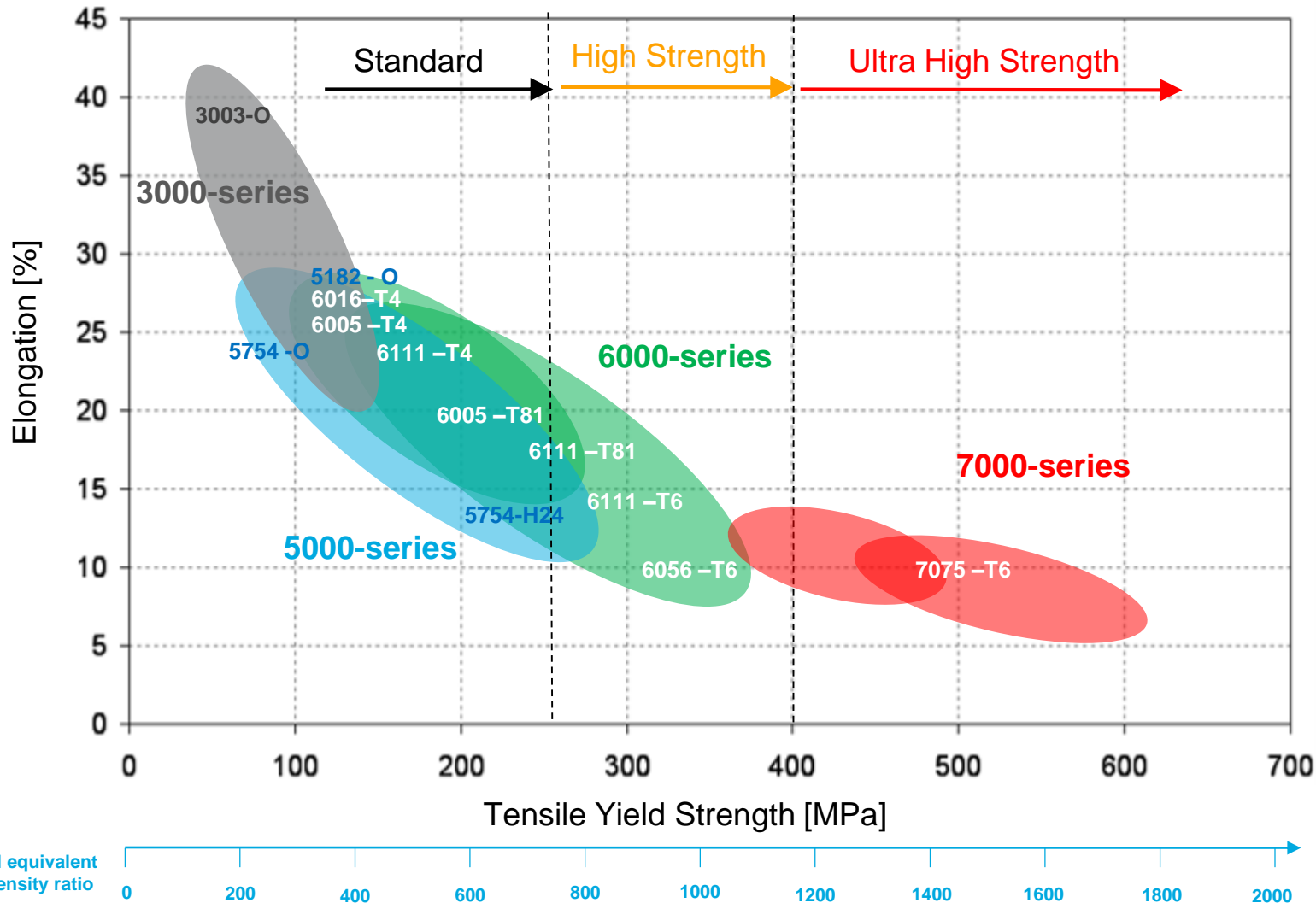

## 6000-series = Al-Mg-Si-(Cu)

- Heat treatable
- Major automotive alloy family
- Very good cold formability in T4 temper
- Gains strength through paint-bake or PFHT
- Excellent corrosion resistance

## 5000-series = Al-Mg

- Non-heat treatable
- Very good cold formability in O-temper
- Can be strengthened by cold work in H-tempers
- Excellent corrosion resistance

## 3000-series = Al-Mn

- Non-heat treatable
- Low strength – excellent formability
- Heat exchangers / heat shields

## 7000-series = Al-Zn-Mg-(Cu)

- Heat treatable – highest strength alloy family
- Currently not in volume automotive use
- Limited cold formability
- Hot stamp + press quenchable
- Can be susceptible to stress corrosion cracking

# Bottom Plate Impact resistance

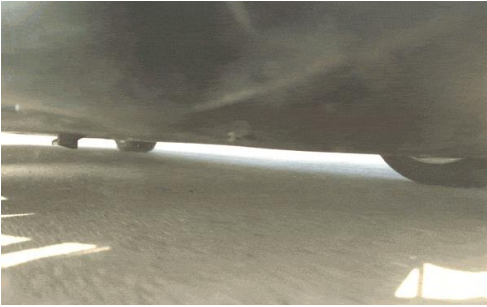

- To evaluate different material, alloy and temper solutions we use an in-house numerical simulation tool backed up by a physical testing protocol
- We record the force vs displacement for up to 15 mm intrusion in different positions of a test sheet firmly fixed in a frame.
- This allows to determine the equivalent gauge based on absorbed energy and therefore weight saving potential of new grades and solutions.

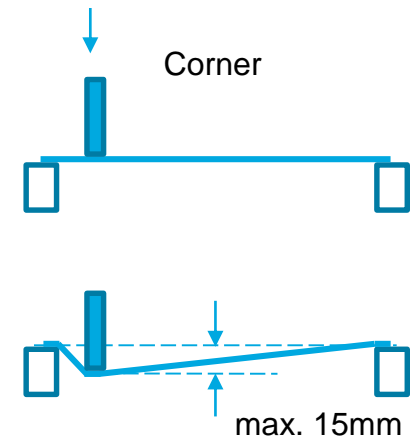
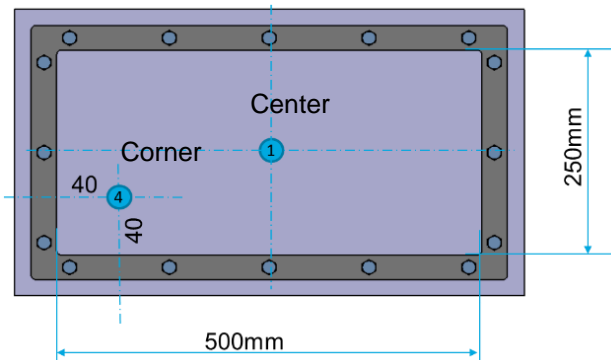
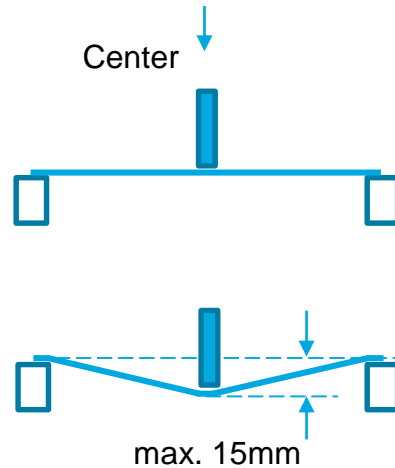

# Bottom Plate Alloy selection

Higher strength alloys allow for significant weight and cost reduction.

Alloy	Temper	TYS [MPa]	UTS [MPa]	E-Mod [GPa]	Status
5754	O-temper	120	250	70	Available
5182	O-temper	150	290	70	Available
5754	H24	225	290	70	Available
6111	T4 + PB	280	340	70	Available
6111	T6 / PFHT	300	360	70	Available
7075	T6	500	530	70	Development
4xxx	T6/PFHT	350	390	80	Development

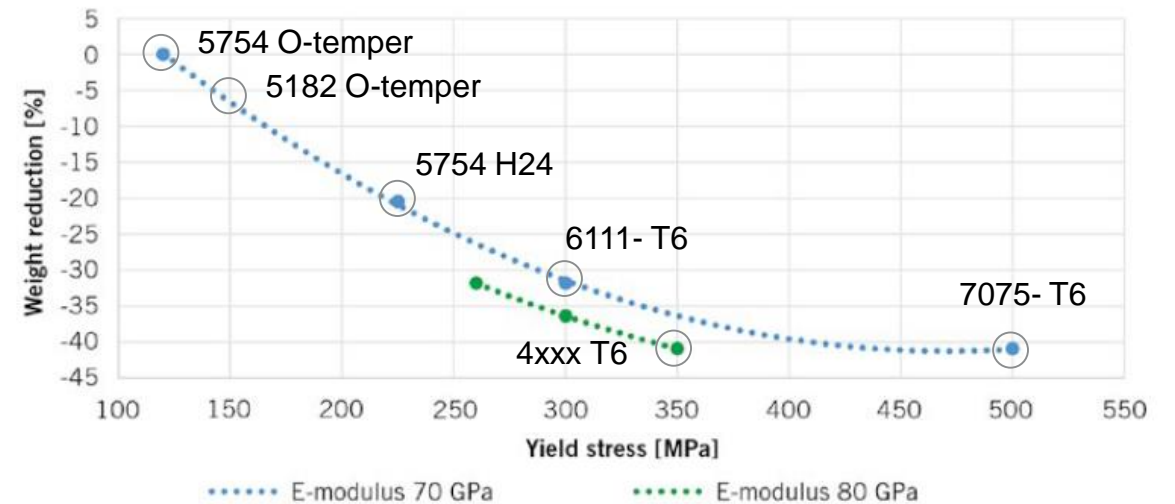

- Current state-of-the-art solution is high strength 6111 in peak aged temper – saves 30% weight vs benchmark 5754 O-temper
- 40% weight reduction is technically feasible with 7075 T6 or with developmental 80 GPa E-modulus / 350 MPa YS 4xxx alloy



# Constellium Extruded Automotive Aluminum alloys

Strength and ductility requirements can be met with advanced 6xxx alloys with excellent corrosion resistance, joinability and ease of recycling.

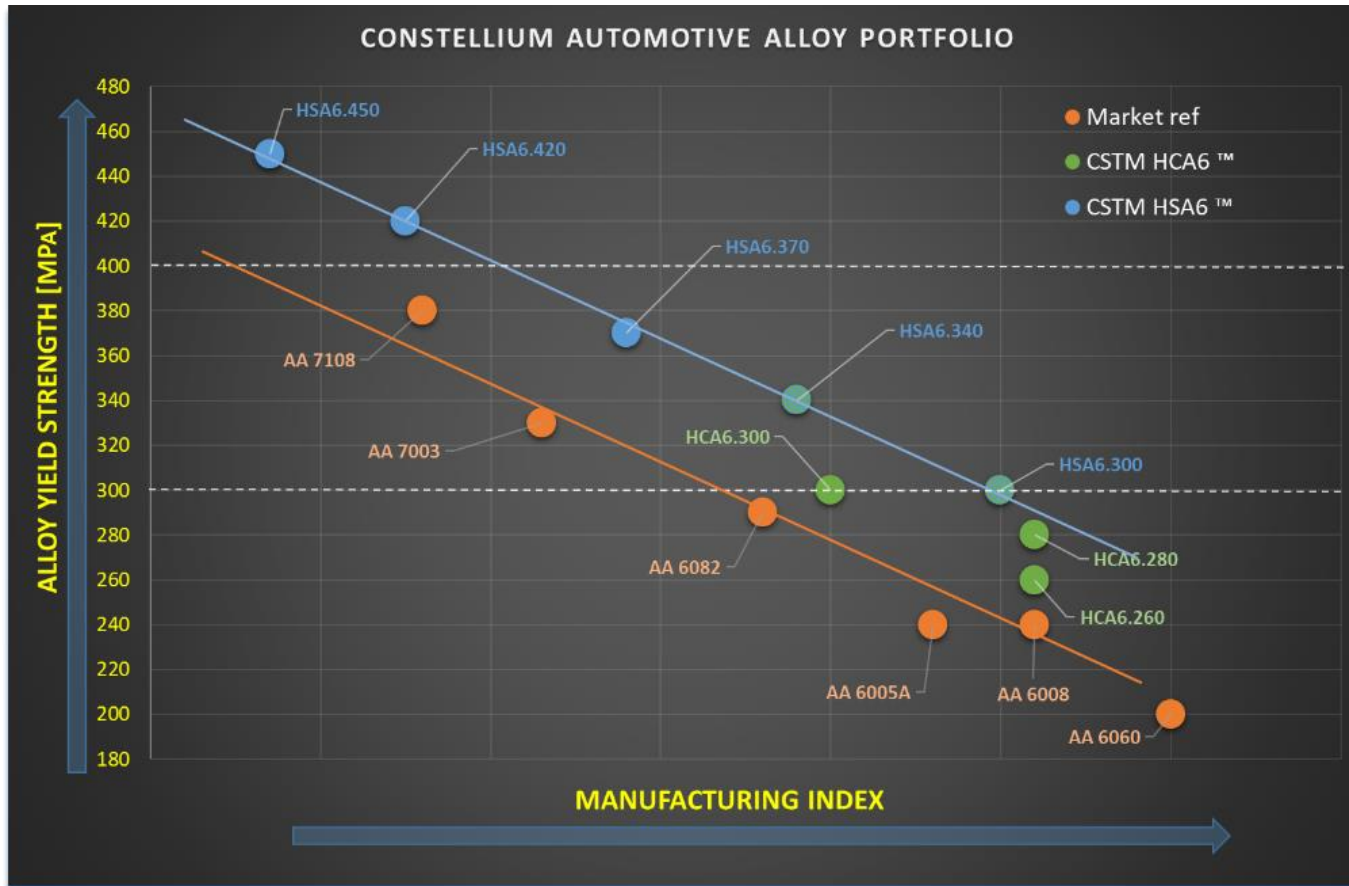

- HSA6™ family are proprietary 6xxx alloys achieving higher strength and better manufacturability than 7xxx series alloys
- HCA6™ family are proprietary high strength 6xxx with high ductility for energy absorption in crash
- Constellium HSA6/HCA6 Aluminium alloys provide Weight Savings of > 20% Versus Conventional Al Alloys

# Dual Material Battery Enclosure Protection System

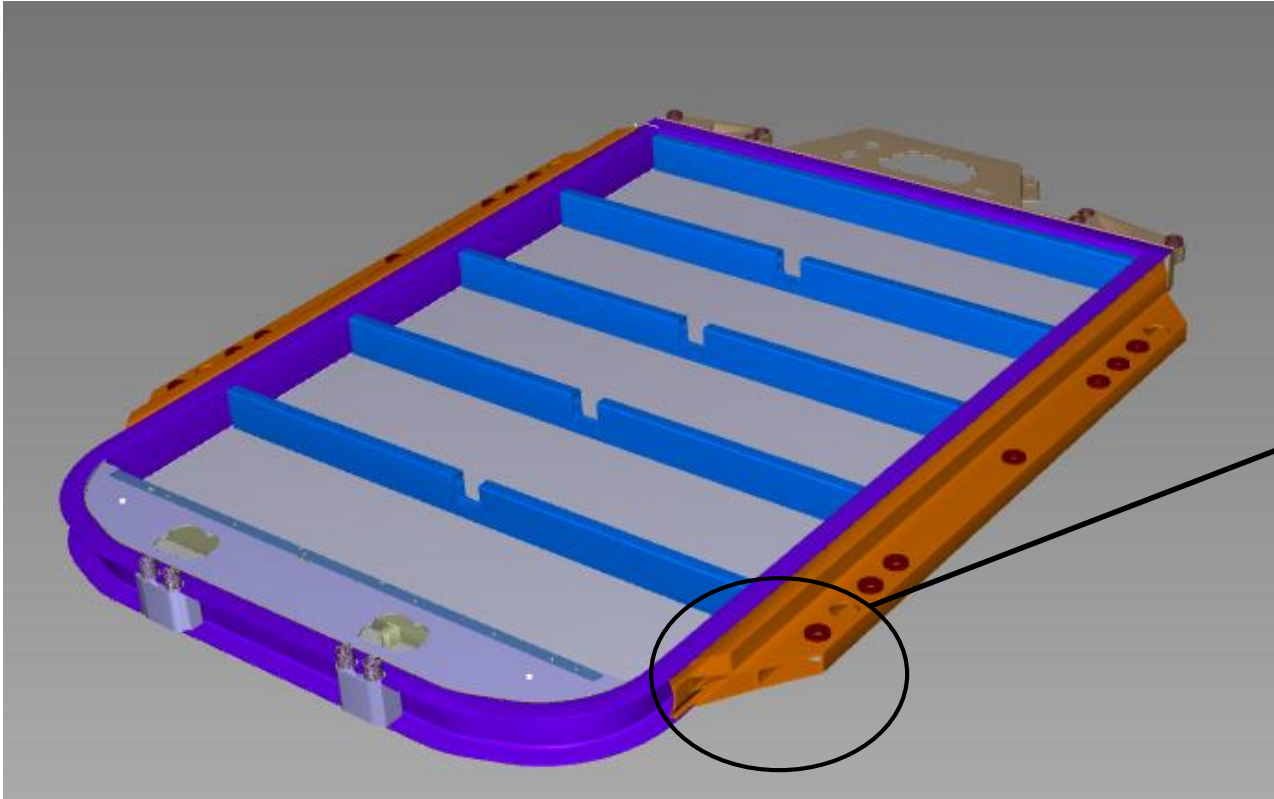

Example Battery Enclosure

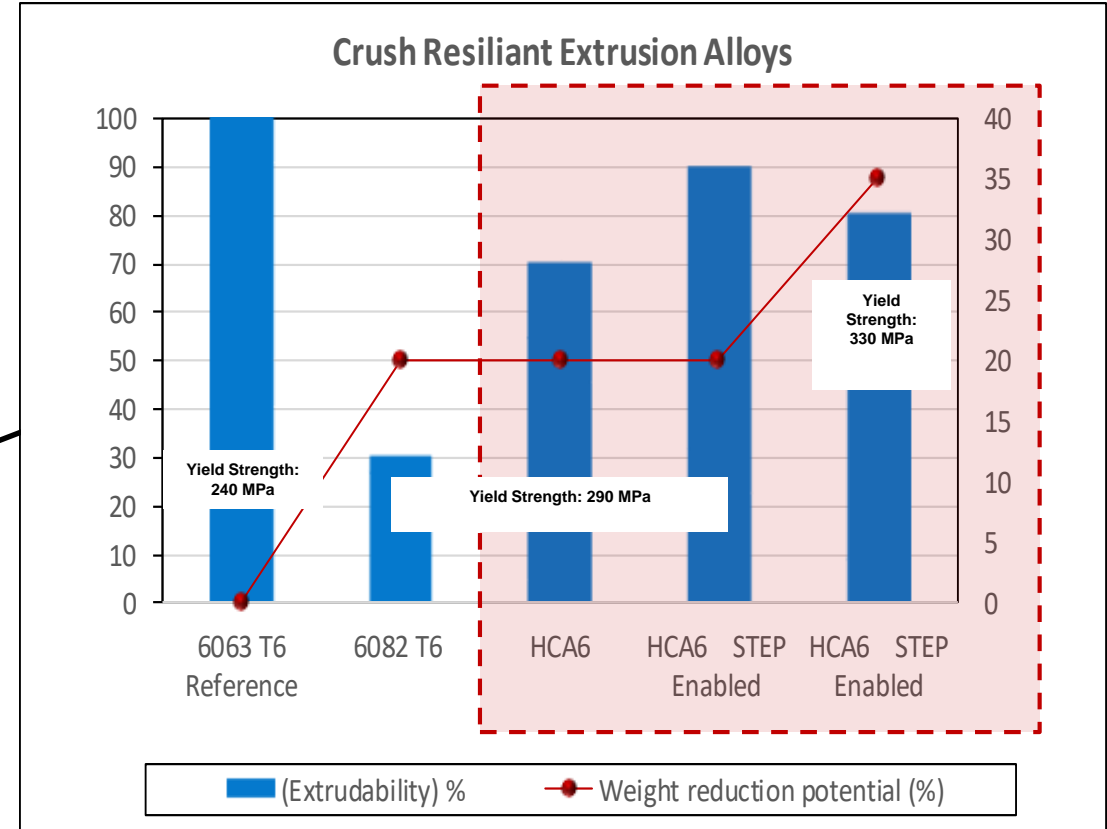

Advanced Extrusion Alloy & Design To Provide Cost Effective Light Weight Solutions



## Summary and conclusions

- Aluminum as sheet and extruded profiles is the preferred material for BEV body structure, closures and battery enclosures.
- Aluminum battery enclosures or other platform parts typically gives a weight saving of 40% compared to an equivalent steel design.
- Light-weight design allows:
  - Better overall performance = range, acceleration, payload, energy consumption and/or
  - Cost savings at iso-performance by downsizing of battery, motors, structure
- Aluminum is infinitely recyclable with zero loss of properties. At end of life 96% of automotive aluminum content is recycled. Recycling aluminum only requires 5% of the energy needed for primary production.
- North American automotive aluminum contains recycled metal and primary metal manufactured mainly with renewable, hydroelectric power.



## Poll #2

What do you think the share of BEV battery enclosures made with aluminum as the main material will be in 2030:

A = 100%

B = 75%

C = 25%

D = 0 %